

CAPACITY
2500 - 3000 kg

KOMATSU®

FB25-12 **FB30-12**

FB
25



Photos may include optional equipment.

ELECTRIC FORKLIFT TRUCK

www.Komatsu.com

Printed in Japan 201402 IP.SIN

KOMATSU®

CEN00541-01

Materials and specifications are subject to change without notice
KOMATSU is a trademark of Komatsu Ltd. Japan

WALK-AROUND

CAPACITY
2500 - 3000 kg

The water-resistant, dustproof and energy-saving electric forklift truck that fulfills customer's needs for wider range of job sites.

Economy & Ecology

- Max. 20% energy-saving contributes to extended operating hours (FB25-12)
- Highly efficient PM (permanent magnet) motor
- A brand-new control system that reduces power consumption
- Optimized truck balance

See page 4.

Safety & Reliability

- Water-resistant, dustproof motor and controller
- Well-sealed DT connectors
- Wider tread contributes to greater stability
- Longer wheelbase contributes to superb travel comfort
- Traveling/lifting Operator Presence Sensing system
- Parking brake with indicator lamp

See page 5.



KOMTRAX

- Komatsu machine tracking system
- See page 9.

Comfort & Operation

- Optimum performance setups
- Overspeed alarm
- A large assist grip and wide step for easy access
- Fully hydrostatic power steering for excellent maneuverability
- Plastic overhead guard cover provides operator comfort in the rain
- Ample overhead clearance
- ID key enables identification of the operating record (optional)
- Rear assist grip with horn button supports easy reverse traveling (optional)

See pages 6 and 7.

ICT (Information & Communication Technology)

- Large color monitor provides the truck status at a glance

See page 8.



ECONOMY AND ECOLOGY

Max. 20% energy-saving contributes to extended operating hours (FB25-12)

Application of a highly efficient PM motor, optimized truck balance, and new control system have resulted in up to a 20% reduction* in power consumption and extended operating hours.

Electric power consumption

Up to 20% energy-saving
[Up to 15% energy-saving for FB30-12]

*Komatsu tested data comparing the FB25-12 and FB25EX-11, and FB30-12 and FB30-11. The results may vary depending on conditions.

Operating hour comparison (General guide)

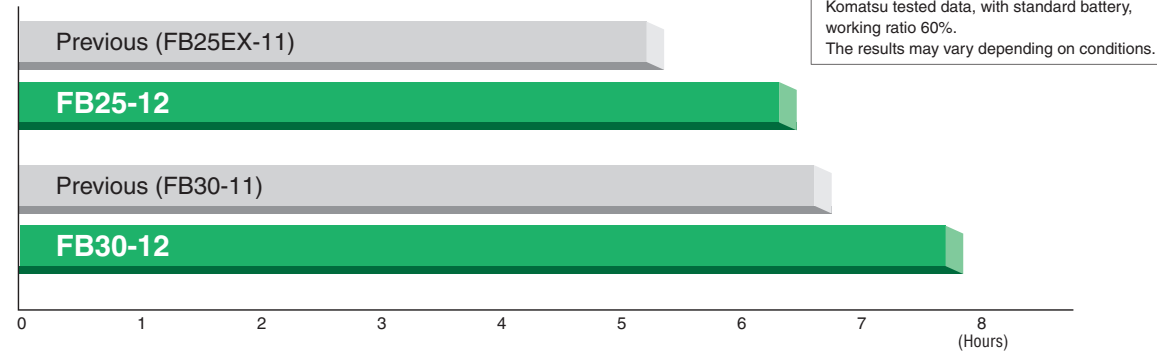

Highly Efficient PM (Permanent Magnet) Motor

The Komatsu FB25/30-12 features a highly efficient PM motor, an AC synchronous motor which uses permanent magnets in the rotor, to power both drive and pump motors. With its low electrical loss characteristics, low energy consumption contributes to longer operating hours.

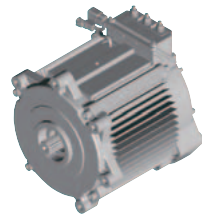

Sealed, highly efficient PM motor



Sealed, highly efficient PM motor

Optimized Truck Balance

The battery is located at the rear end of the truck. The truck balance is optimized, and it is contributing to extended operating hours.



Location of battery

A Brand-new Control System that Reduces Power Consumption

The FB25/30-12 features a torque-control system that reduces power consumption at peak motor loads. The control system helps to provide longer operating hours by reducing electrical loss and making efficient use of energy during acceleration.



SAFETY AND RELIABILITY

Excellent reliability and enhanced stability, optimum for outdoor usages or on dusty job sites

Water-resistant, Dustproof Motor and Controller

The FB25/30-12 employs sealed motors and a new cooling system that does not allow direct intake of ambient air to the controllers and other electrical components. Together with waterproof connectors and covers, both waterproofing and dustproofing features have been improved. The FB25/30-12 meets the IPx4 waterproof standard. The improved dustproofing and waterproofing features realize excellent reliability even in wet weather when washing the truck using hose water, or on dusty job sites.

*Follow the instructions in the operation & maintenance manual when washing the truck.

Meet with IPx4 Waterproof Standard



IPx4

The IP code or International Protection Rating classifies and rates the degree of protection provided against the intrusion of solid objects and water. IPx4 is protection against splashing water from all directions, therefore, the FB25/30-12 is protected against water splash from underneath chassis or hose water when washing the truck.

IP Code	Protection against	Testing for	
IPx4	Splashing water	Water splashing against the enclosure from any direction shall have no harmful effect.	FB25/30-12
IPx3	Spraying water	Water falling as a spray at any angle up to 60° from the vertical shall have no harmful effect.	Previous

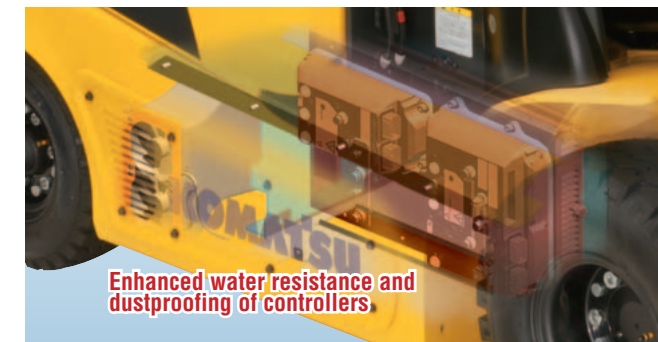

Enhanced water resistance and dustproofing of controllers

Well-sealed DT Connectors

Major electrical harnesses and controllers in the FB25/30-12 employ the DT connectors, they are also used in Komatsu construction machinery, for superior waterproofing and dustproofing ability.



Wider Tread Contributes to Greater Stability

The wider tread of the FB25-12 provides greater stability when handling a load.

FB25-12 Load capacity at 5.0 m lift height, 1900 kg

(Previous 1800 kg)
5.0 m 2-stage free view mast, standard fork, single tire, load center 500 mm



Longer Wheelbase Contributes to Superb Travel Comfort

The longer wheelbase provides greater longitudinal stability and reduced pitching, which enhances travel comfort.

FB25-12 Wheelbase 1550 mm

(Previous 1400 mm)



Traveling/lifting Operator Presence Sensing System

The traveling/lifting Operator Presence Sensing system allows traveling or lifting only when the operator is seated. It provides a double safety measure by requiring the operator to sit securely and return the directional lever to the neutral position before traveling.



*The traveling interlocking function cuts off power transmission but does not serve to apply the brake.

● The interlock state is also indicated on the color monitor.

Parking Brake with Indicator Lamp

When the operator leaves from the truck without setting the parking brake, an indicator lamp flashes and buzzer sounds intermittently. The buzzer also sounds if the operator presses the accelerator pedal while the parking brake is engaged, thereby protecting against excessive brake wear.



COMFORT AND OPERATION

Optimum performance setups

Functions such as traveling, lifting and tilting speeds can be adjusted according to individual needs. These adjustments can be easily made using the color monitor screen. With optimum performance setups, operations can be individually optimized, making operations smoother and more comfortable.

Travel power setup	Lift speed setup Tilt speed setup	Downslope travel setup	Plugging regeneration setup	Accelerator neutral regeneration setup
3 steps	10 steps	ON/OFF	10 steps	10 steps
Travel power mode setup*	Lift/Tilt speed setup*	Downslope travel setup	Switchback distance setup	Accelerator neutral regeneration setup

Customize performance to suit your preferences:	<input type="checkbox"/> ES volume setup (8 steps)* <input type="checkbox"/> Soft start characteristic setup (3 steps)	<input type="checkbox"/> Accelerator characteristic setup (3 steps) <input type="checkbox"/> Attachment speed setup (10 steps)	<input type="checkbox"/> Travel speed limit setup (1 km/h increments)*
---	---	---	---

Please request your Komatsu Sales and Service Representative to perform customization setups.
 Note: Items marked with an asterisk (*) may be adjusted by the operator.

Comfort Setup

Set the Travel power and Lift/Tilt speeds lower for less stable load handling or operations in cramped work places. The operator can carry out the job with ease.

Overspeed Alarm

The FB25/30-12 is equipped with an overspeed alarm, which sounds when the operator exceeds the specified speed limit. This setting may be adjusted in 1 km/h increments, and can be made using the color monitor screen.

A Large Assist Grip and Wide Step for Easy Access

The large assist grip, combined with a wide floor and step, leads to a roomy entrance to make it easy for an operator to get on and off.



Powerful Setup

Set the Travel power and Lift/Tilt speeds higher for high-cycle operations. The truck will produce its maximum performance.

Fully Hydrostatic Power Steering for Excellent Maneuverability

The FB25/30-12 features a small-diameter steering wheel with an ergonomically optimized design. The fully hydrostatic power steering mechanism provides excellent maneuverability in the switchback operations. The steering knob synchronizer function is also included as a standard feature.



Plastic Overhead Guard Cover Provides Operator Comfort in The Rain

A plastic overhead guard cover is equipped as standard to provide operator comfort in the rain.



Ample Overhead Clearance

Overhead clearance is ample for operators wearing a helmet. This enhances comfort operator work place.



ID Key Enables Identification of The Operating Record (optional)

ID key is available as an option to enable individual tracking of operation. Since the truck can only be operated using a registered ID key, it also serves as an effective means of theft prevention.

Rear Assist Grip with Horn Button Supports Easy Reverse Traveling (optional)

Grasping the rear assist grip helps to stabilize the operator's posture while traveling in reverse. And the horn switch on the grip enables the operator to use the horn easily.



ICT (Information & Communication Technology)

Large color monitor provides the truck status at a glance

The large, user-friendly color monitor enables accurate and smooth operation. Checking the truck speed, battery discharge, and other essential information is easy and at a glance. Function keys facilitate easy setup of travel or lifting modes and travel speed limit.



- 1 Hour meter (SMR) integration state
- 2 Parking brake indication
- 3 Load handling interlock indication
- 4 Travel interlock indication
- 5 Load handling power mode
- 6 Travel power mode
- 7 Clock / Hour meter (SMR) / Travel distance (Odometer) indication / Caution symbol
- 8 Travel speed
- 9 Directional lever position / Action level monitor
- 10 Battery discharge indicator (BDI)
- 11 Average power consumption *
- 12 Instantaneous power consumption (ECO gauge) *
- 13 Guidance icon
- 14 Function button

*Available on truck with KOMTRAX

Working Information Menu

Press the function button to check a wide range of information.

- Hour meter (SMR)
- Traveling hours
- Load handling hours
- Actual working hours
- Actual working hours ratio
- Electric power last charging
- Electric power accumulated
- CO₂ emission accumulated

Consumed Electric Power Record

(Available on truck with KOMTRAX)

You can check the electric power consumption for either the last 12 hours or the last 7 days of operation.

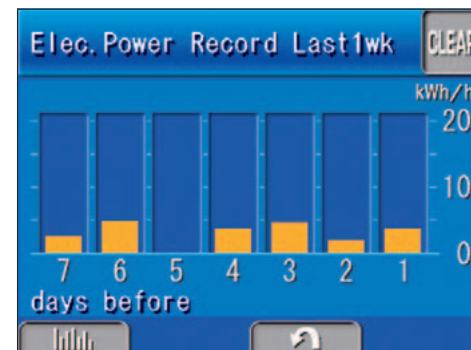

Power consumption indication

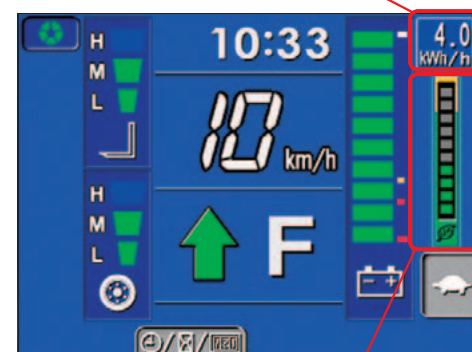

Instantaneous power consumption (ECO gauge)

Average Power Consumption / Instantaneous Power Consumption (ECO gauge)

(Available on truck with KOMTRAX)

Power consumption indication shows average electric power consumption for that day.

Instantaneous power consumption (ECO gauge) shows average electric power consumption for the last three seconds to guide for energy saving operation.

KOMTRAX

Komatsu Machine Tracking System

KOMTRAX* can provide various machine information including location information, operation information and power consumption information to the customer. In addition, to offer "Ease" and "Dependability" to the customer, Komatsu supports our customers so that they can use their Komatsu machines in the best condition at all times by using KOMTRAX information and through its services network.

*KOMTRAX availability is subject to country or region.

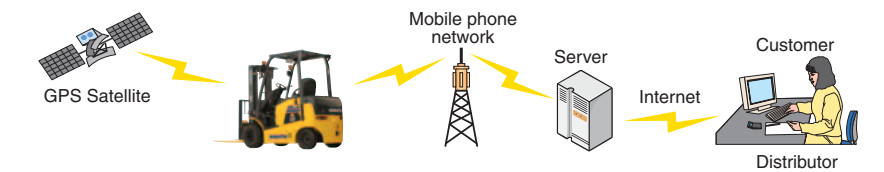

*KOMTRAX is using the mobile phone network. It may be able to be used at the place where an electric wave does not reach, or at the weak place of an electric wave.

Machine Operation Information

Grasping details of machine operation information on a daily basis makes it possible to understand power consumptions and running costs.

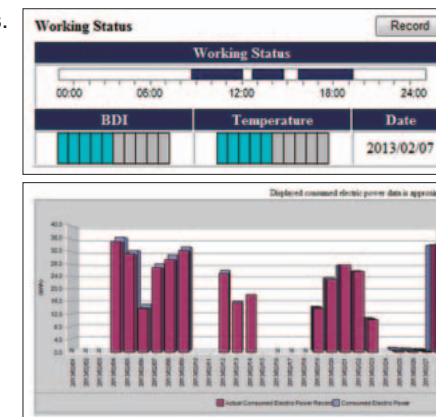

Operation Report

Monthly and annual operation records provided by KOMTRAX are useful information for the customer.

Machine Location Information

Grasping machine location information allows machine operation management.

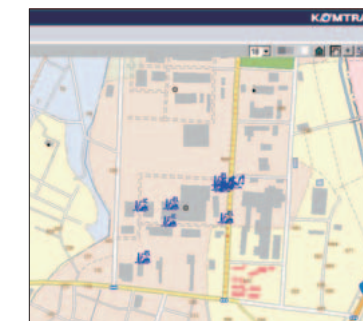

SPECIFICATIONS AND EQUIPMENT

SPECIFICATIONS

Characteristics	Model		Manufacturer's Designation		FB25-12	FB30-12		
	1.2	Model		Manufacturer's Designation		FB25-12	FB30-12	
1.3	Power Type		Electric, Diesel, Gasoline, LPG, Cable		Electric	Electric		
1.4	Operation Type		Pedestrian, Driver standing, Sitting, Order picking		Sitting	Sitting		
1.5	Rated Capacity	Q	Rated Capacity	kg	2500	3000		
1.6	Load Center	c	Rated Load Center	mm	500	500		
1.6.1	Alternative Capacity	Q2	Capacity @600mm Load Center	kg	2260	2720		
1.8	Load Distance	x	Front Axle Center to Fork Face	mm	450	490		
1.9	Wheelbase	y		mm	1550	1650		
Weight	2.1	Service Weight		Including Min. Capacity Battery, See line 6.5	kg	3800	4660	
	2.2	Loaded		Front	kg	5585	6780	
	2.2.1	Axle Loading		Rear	kg	715	880	
	2.3	Unloaded		Front	kg	1520	1935	
2.3.1			Rear	kg	2280	2725		
Tires	3.1	Tire Type		Cushion, Elastic Cushion, Pneumatic, Polyurethane		Pneumatic	Pneumatic	
	3.2	Tire Size		Front		23 x 9-10-16PR	28 x 9-15-14PR	
	3.3			Rear		18 x 7-8-16PR	21 x 8-9-10PR	
	3.5	Number of Wheel		Front/Rear (x=driven)		2x/2	2x/2	
3.6	Tread, Front		b10	mm	975	1005		
3.7	Tread, Rear		b11	mm	960	980		
Dimensions	4.1	Tilting Angle		α / β	Forward/Backward	degree	6/11	6/11
	4.2	Mast Height, Lowered		h1	2-stage Mast	mm	1995	2065
	4.3	Std. Free Lift		h2	2-stage Std. Mast, from Ground	mm	155	160
	4.4	Std. Lift Height		h3	2-stage Std. Mast, from Ground	mm	3000	3000
	4.5	Mast Height, Extended		h4	2-stage Std. Mast	mm	4050	4270
	4.7	Height, Overhead Guard		h6		mm	2155	2215
	4.19	Length, with Std. Forks		L1		mm	3515	3710
	4.20	Length, to Fork Face		L2		mm	2445	2640
	4.21	Width, at Tire		b1	Single	mm	1200	1235
	4.22	Forks		s/e/l	Thickness x Width x Length	mm	40 x 122 x 1070	45 x 122 x 1070
	4.23	Fork Carriage Class		ISO 2328, Type A/B/no			class2, A	class3, A
	4.24	Width, Fork Carriage		b3		mm	1020	1060
	4.31	Ground Clearance		m1	Under Mast	mm	115	140
	4.32			m2	at Center of Wheelbase	mm	110	145
4.33	Aisle Width *		Ast	with L1000 x W1200 pallet	mm	3840	4060	
4.34			Ast	with L1200 x W800 pallet	mm	3970	4190	
4.35	Turning Radius		Wa		mm	2120	2300	
Performance	5.1	Travel Speed (FWD)		Loaded	km/h	14.0	13.5	
				Unloaded	km/h	16.0	15.5	
	5.2	Lifting Speed		Loaded	mm/s	260	330	
				Unloaded	mm/s	550	550	
	5.3	Lowering Speed		Loaded	mm/s	500	420	
				Unloaded	mm/s	540	450	
	5.6	Max. Drawbar Pull		Loaded 1.5 km/h, 3 min rating	N	10900	13200	
5.8	Max. Gradeability		Loaded 1.5 km/h, 3 min rating	%	16	18		
5.10	Service Brake		Operation/Type		Foot/Hydraulic	Foot/Hydraulic		
5.11	Parking Brake		Operation/Control		Hand/Mechanical	Hand/Mechanical		
5.12	Steering		Type		FHPS	FHPS		
Drive	6.1	Drive Motor		60 min. rating	kW	9.6	12.0	
	6.2	Pump Motor		5 min. rating	kW	10.3	14.1	
	6.2.1	PS Motor		60 min. rating	kW	-	-	
	6.4	Battery Voltage			V	72	72	
	6.4.1	Battery Capacity, Min			Ah/5hr	360	450	
6.4.2	Battery Capacity, Max			Ah/5hr	470	545		
6.5	Battery Weight		Min.Capacity Battery, See line 6.4.1	kg	1085	1145		
Others	8.1	Drive Motor Control				AC, MOSFET inverter	AC, MOSFET inverter	
	8.2	Relief Pressure for Attachment			Mpa	18.1	18.1	
	8.2.1	Hydraulic Tank Capacity			L	25	26	

* : VDI 2198 includes 200 mm clearance

MAXIMUM LOAD AND OVERALL HEIGHT OF MAST BY LIFTING HEIGHT

2-stage free view mast (Single tire, load center 500 mm)

Maximum fork height (mm)	Load capacity (kg)		Overall height (mm) [Lowered / Extended]	
	model	FB25-12	FB30-12	FB25-12
3000	2500	3000	1995/4050	2065/4270
3300	2500	3000	2145/4350	2215/4570
3500	2500	3000	2245/4550	2315/4770
4000	2500	3000	2545/5050	2615/5270
4500	2300	2700	2795/5550	2865/5770
5000	1900	2200	3095/6050	3165/6270

3-stage full free view mast (Single tire, load center 500 mm)

Maximum fork height (mm)	Load capacity (kg)		Overall height (mm) [Lowered / Extended]	
	model	FB25-12	FB30-12	FB25-12
4000	2400	2950	1895/5080	1965/5300
4300	2300	2850	1995/5380	2065/5600
4500	2050	2700	2070/5580	2140/5800
4700	2050	2500	2145/5780	2215/6000
5000	1650	2200	2245/6080	2315/6300
5500	1250	1500	2445/6580	2515/6800
6000	950	1100	2645/7080	2715/7300

2-stage full free view mast (Single tire, load center 500 mm)

Maximum fork height (mm)	Load capacity (kg)		Overall height (mm) [Lowered / Extended]	
	model	FB25-12	FB30-12	FB25-12
3000	2500	3000	1995/4050	2065/4270

DIMENSIONS

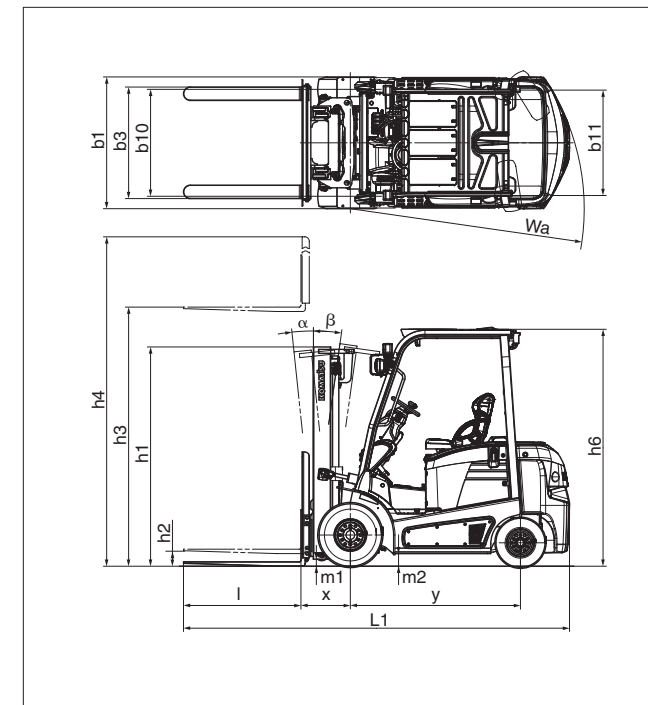

AISLE WIDTH

Model	Length of pallet (mm)	Width of pallet (mm)				
		900	1000	1100	1200	1300
FB25-12	900	3840	3840	3840	3840	3840
	1000	3840	3840	3840	3840	3840
	1100	3870	3870	3870	3870	3870
	1200	3970	3970	3970	3970	3970
	1300	4070	4070	4070	4070	4070
FB30-12	900	4060	4060	4060	4060	4060
	1000	4060	4060	4060	4060	4060
	1100	4090	4090	4090	4090	4090
	1200	4190	4190	4190	4190	4190
	1300	4290	4290	4290	4290	4290

LOAD CAPACITY CURVE

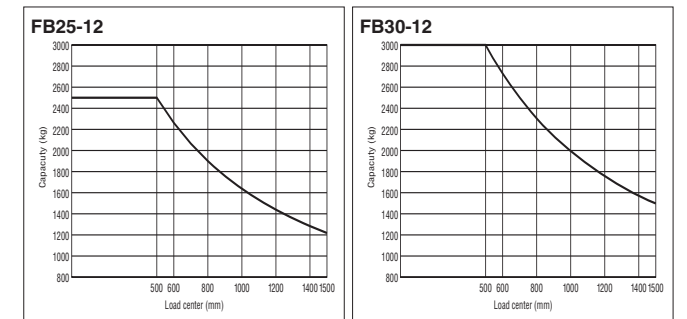

STANDARD EQUIPMENT

- Drive PM motor
- Pump PM motor
- Travel power setup
- ES volume setup
- Load Handling power setup
- Lift speed setup
- Tilt speed setup
- Travel/Brake/Load Handling characteristics setup
- Parking brake with release button
- Overhead guard with front / rear rain gutter
- Rear view mirror (center)
- Neutral start function
- Travel speed limiter (Tortoise) function
- Max. travel speed limit
- Overspeed alarm
- Operator presence sensing system
- Lift lock function
- Back-up buzzer
- Large color monitor
- Fully hydrostatic power steering
- Tilttable steering column
- Steering knob synchronizer function
- Standard directional lever
- Combination switch (turn signal lamp & headlamp switch)
- Standard brake pedal
- Floor mat
- Plastic overhead guard cover
- Halogen headlamps & rear combination lamps with bulbs
- Sealed DT connectors
- Flat face-to-face O-ring seals

Tire:
• Front single tire, pneumatic
• Rear tire, pneumatic

Fork:
• 1070 mm

OPTIONAL EQUIPMENT

- Canvas cab
- Front glass with wiper
- Seat heater
- Tilt cylinder boots
- ID key
- Two front working lamps, fender mounted
- One rear working lamp, overhead guard mounted
- LED flash beacon (yellow), overhead guard mounted
- Headlamps & rear combination lamps with LED
- Two front working lamps with LED, fender mounted
- One rear working lamp with LED, overhead guard mounted
- Forward travel chime
- Forward/Backward travel chime
- Back up buzzer with volume adjust
- Rear view mirror (pair)
- Mast tilt gauge
- Rear assist grip with horn button
- Pressure regulator valve
- Battery sling jig
- Side shifter
- Control valves for attachment
- Dust-proof specification

Fork:
• 920 mm
• 1150 mm
• 1220 mm
• 1370 mm
• 1520 mm
• 1670 mm
• 1820 mm
• 2000 mm
• 2120 mm
• 2200 mm